

MAGNETIC PARTICLE BRAKE B15 - 2

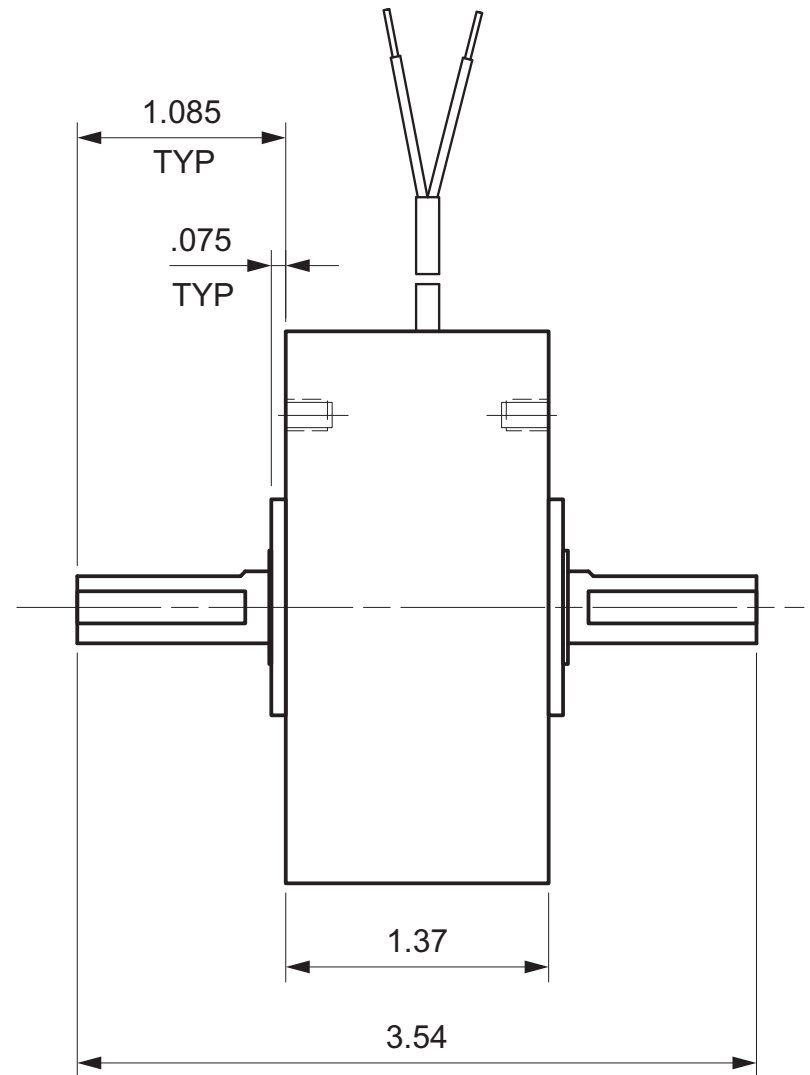
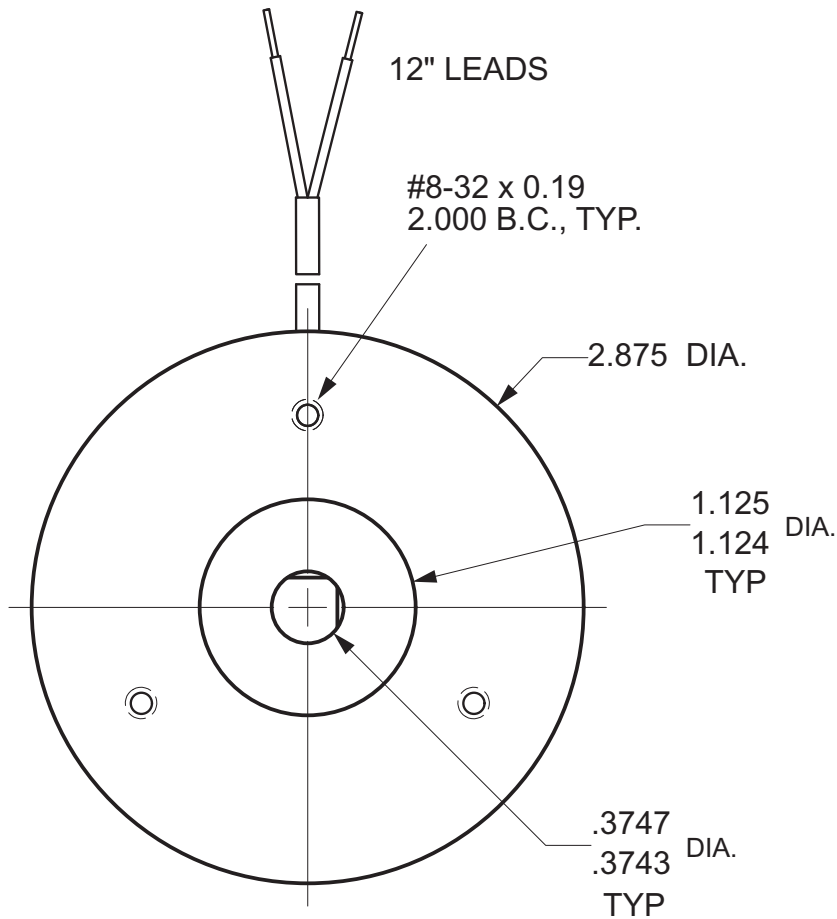

B15-1, Shaft out 1 side
B15-2, Shaft out 2 sides (as shown)
B15-H, Hollow shaft

Units : inches
Scale : full

Drawn 9/27/01
Changed 9/27/01

Elmira, NY 14901 USA
Telephone: 518-523-2422
www.placidindustries.com

