

MAGNETIC PARTICLE BRAKE B115 - H

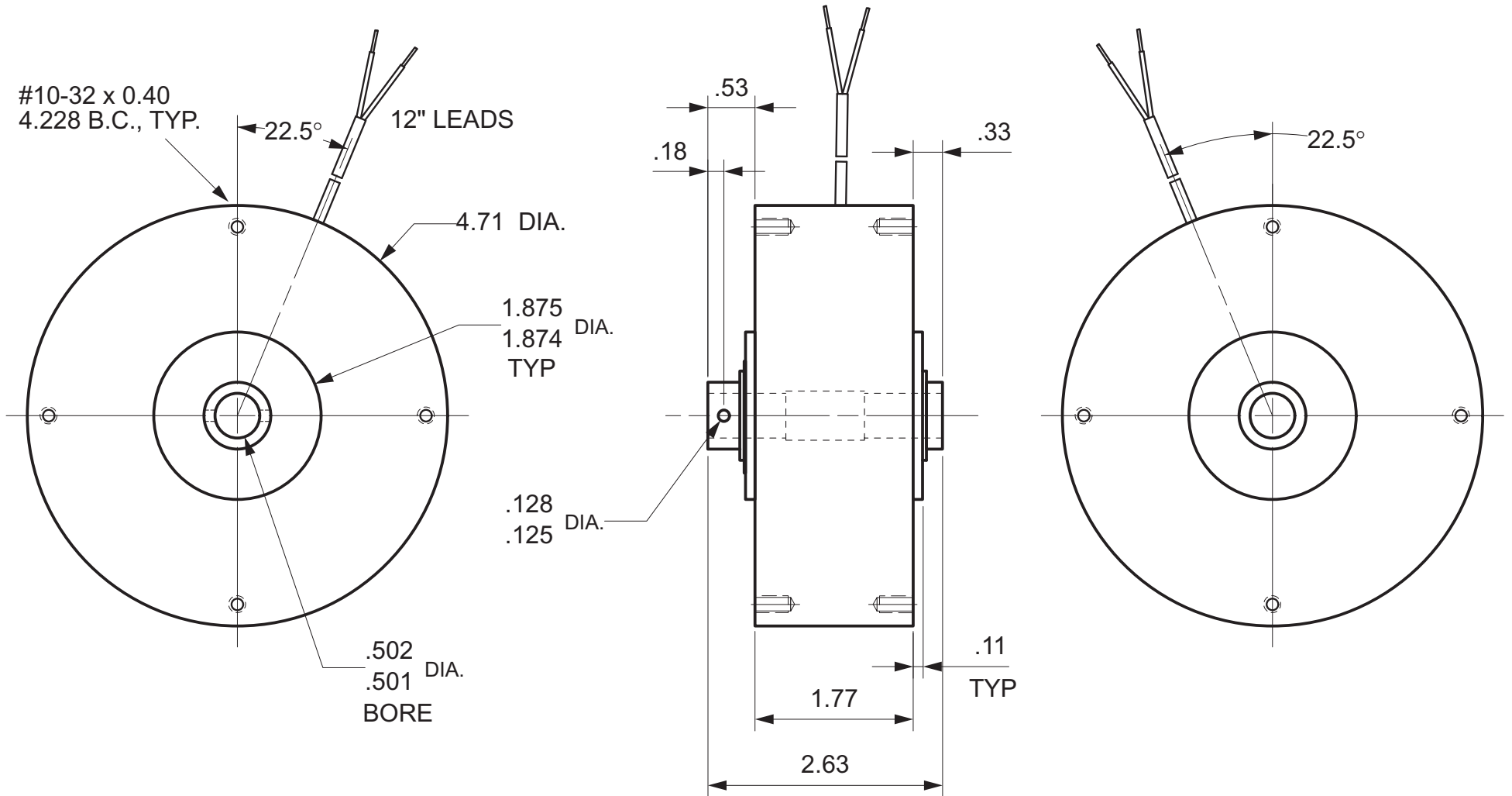

B115-1, Shaft out 1 side
B115-H, Hollow shaft (as shown)

Units : inches
Scale : 60%

Drawn 9/27/01
Changed 9/27/01

Elmira, NY 14901 USA
Telephone: 518-523-2422
www.placidindustries.com

