

HYSTERESIS BRAKE H250 - 2M

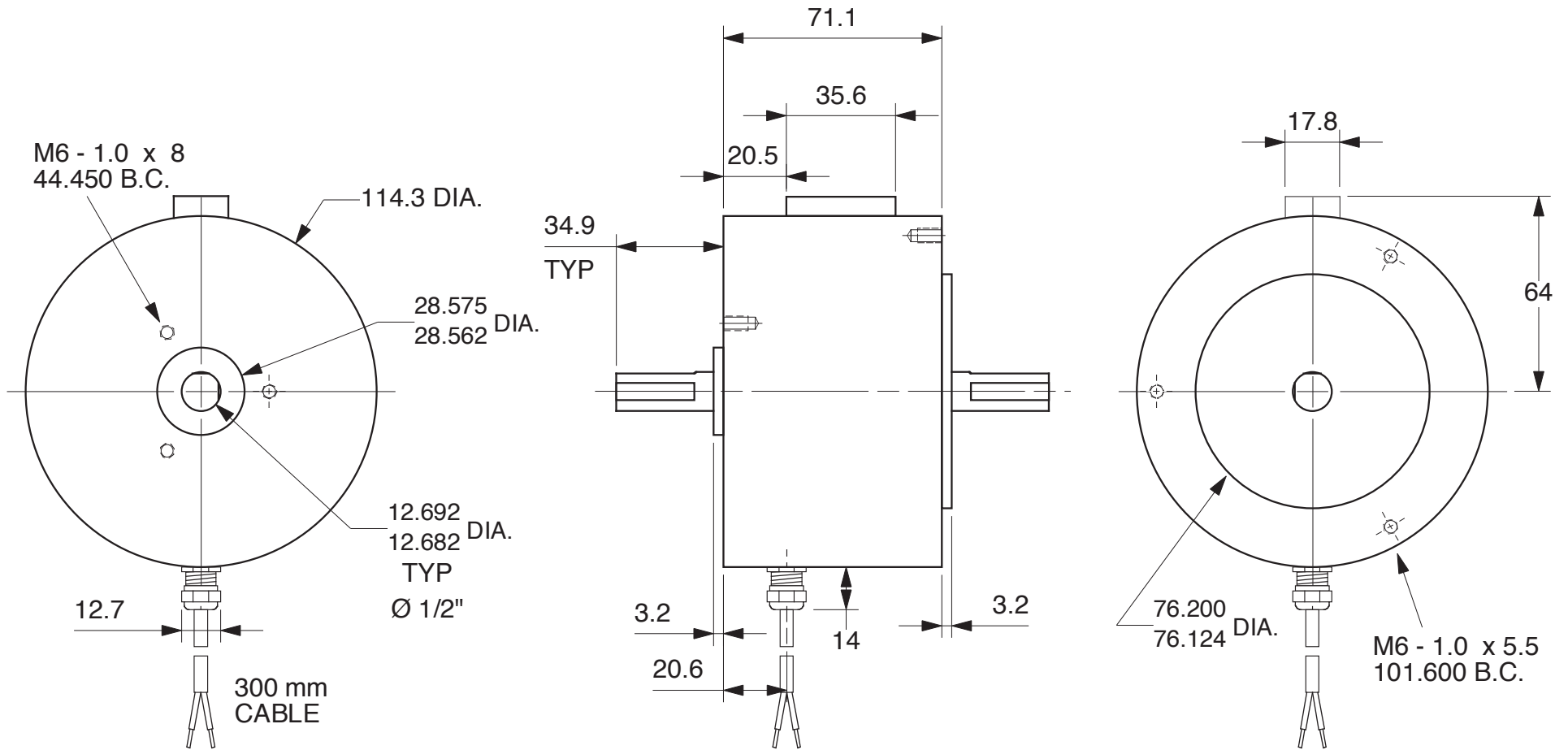

Units : mm
Scale : 50%

Drawn 9/27/01
Changed 9/27/01

Elmira, NY 14901 USA
Telephone: 518-523-2422
www.placidindustries.com

